

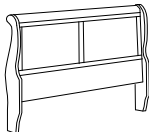

# ASSEMBLY INSTRUCTIONS

MODEL : IDB03 KING BED		
NO.	PART LIST	QTY
A	Head Board 	1 PC
B	Foot Board 	1 PC
C	Side Rail 	2 PCS
D	Bottom Rail 	5 PCS
E	Bottom Rail Support 	5 PCS
NO.	HARDWARE LIST	QTY
F	CSK SCREW M4 x 32mm 	10 PCS
G	CSK SCREW M4 x 16mm 	16 PCS
H	Bracket 	4 PCS

STEP 1 : Attach Side Rail ( C ) to Head Board ( A ) Closely and push down to fit it. Repeat the same step to fitting the Foot Board ( B ).

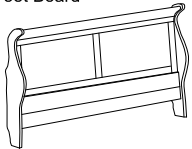
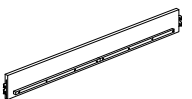
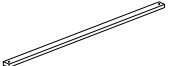
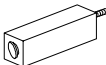

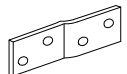
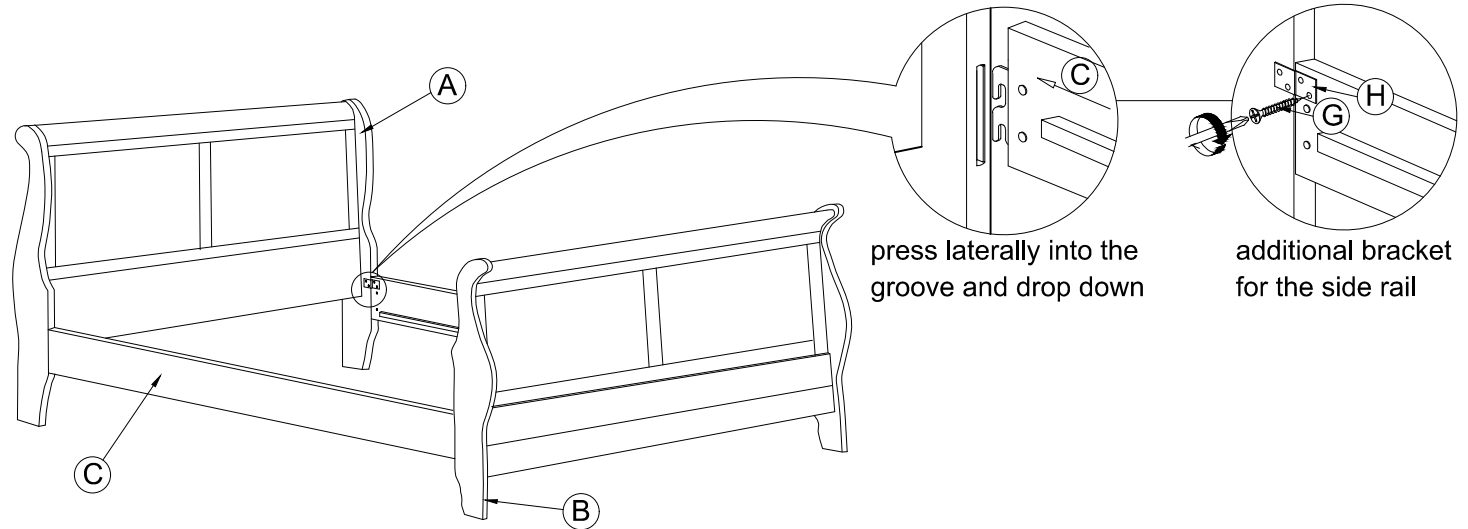
STEP 2 : Fix the Bottom Rail Support ( E ) with Adjuster to Bottom Rail ( D ). Attach the assembled Bottom Rail ( D ) to Side Rail ( C ) as picture shown. Loosen and tighten Adjuster for the stability of bed. Lastly, tighten the Bottom Rail ( D ) with CSK Screw ( F ).  
( NOTE : THE SETUP MUST DONE AT THE DECIDED LOCATION FOR THE BED TO OBTAIN PERFECT STABILITY )

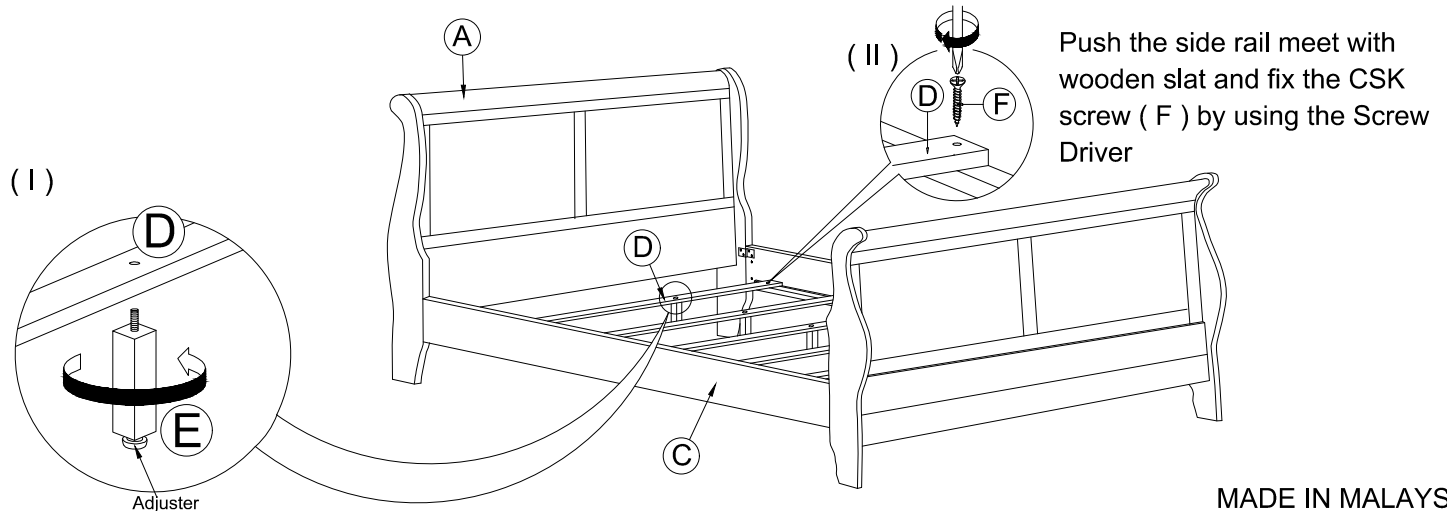

MADE IN MALAYSIA

NOTE : MUST TIGHTEN SCREWS PERIODICALLY WITH USE SCREW WILL BECOME LOOSE, CHECK TIGHTNESS OF ALL SCREW EVERY 6-8 WEEKS